

ScanX Edge

The following information supplements the installation and operating instructions of the unit.

As a general rule, the installation and operating instructions of the device must also be observed. These instructions include important information such as safety instructions and information on the setup, electrical connections, disinfection process, cleaning process etc.



DÜRR DENTAL SE
 Höpfigheimer Str. 17
 74321 Bietigheim-Bissingen
 Germany

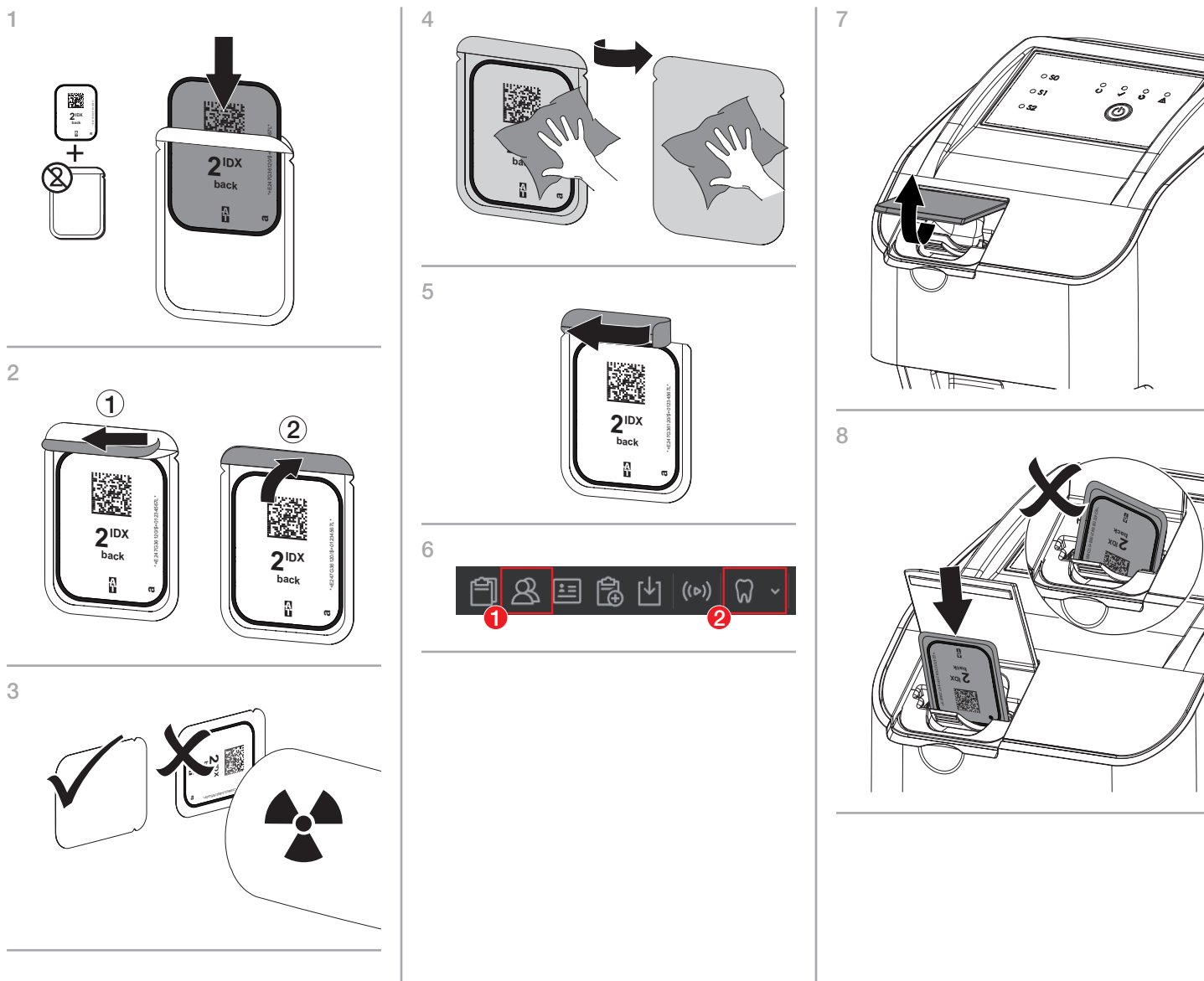

Manufactured for / Distributed by:
 Air Techniques, Inc. | 1295 Walt Whitman Road
 Melville, New York 11747- 3062, USA
 Phone: 800-247-8324 | Fax: 888-247-8481



21601100286L41 X8301 2507V002

9

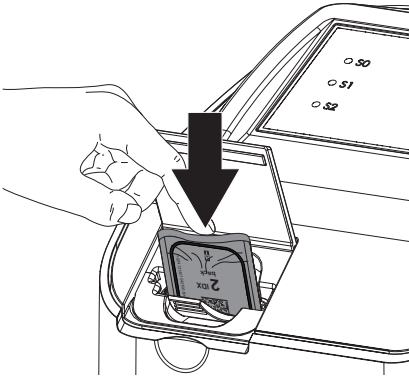

10

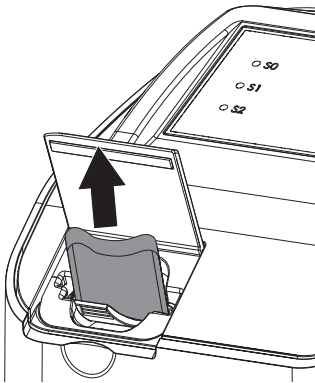

11

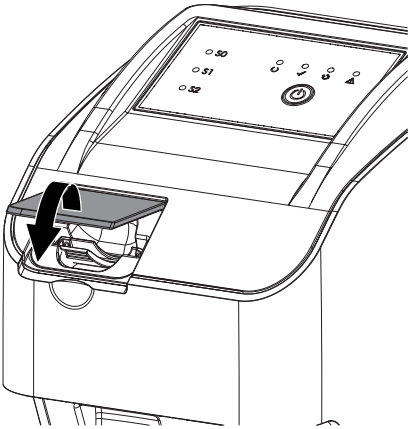

12

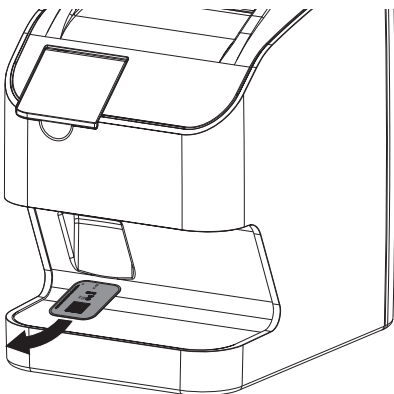

ScanX Edge

La siguiente información es un complemento de las instrucciones de uso y montaje del aparato.

En principio, deben tenerse en cuenta además las instrucciones de uso y de montaje, en las que se describe importante información como, p. ej., advertencias de seguridad, instalación, conexión eléctrica, desinfección, limpieza, etc.



DÜRR DENTAL SE
 Höpfigheimer Str. 17
 74321 Bietigheim-Bissingen
 Germany

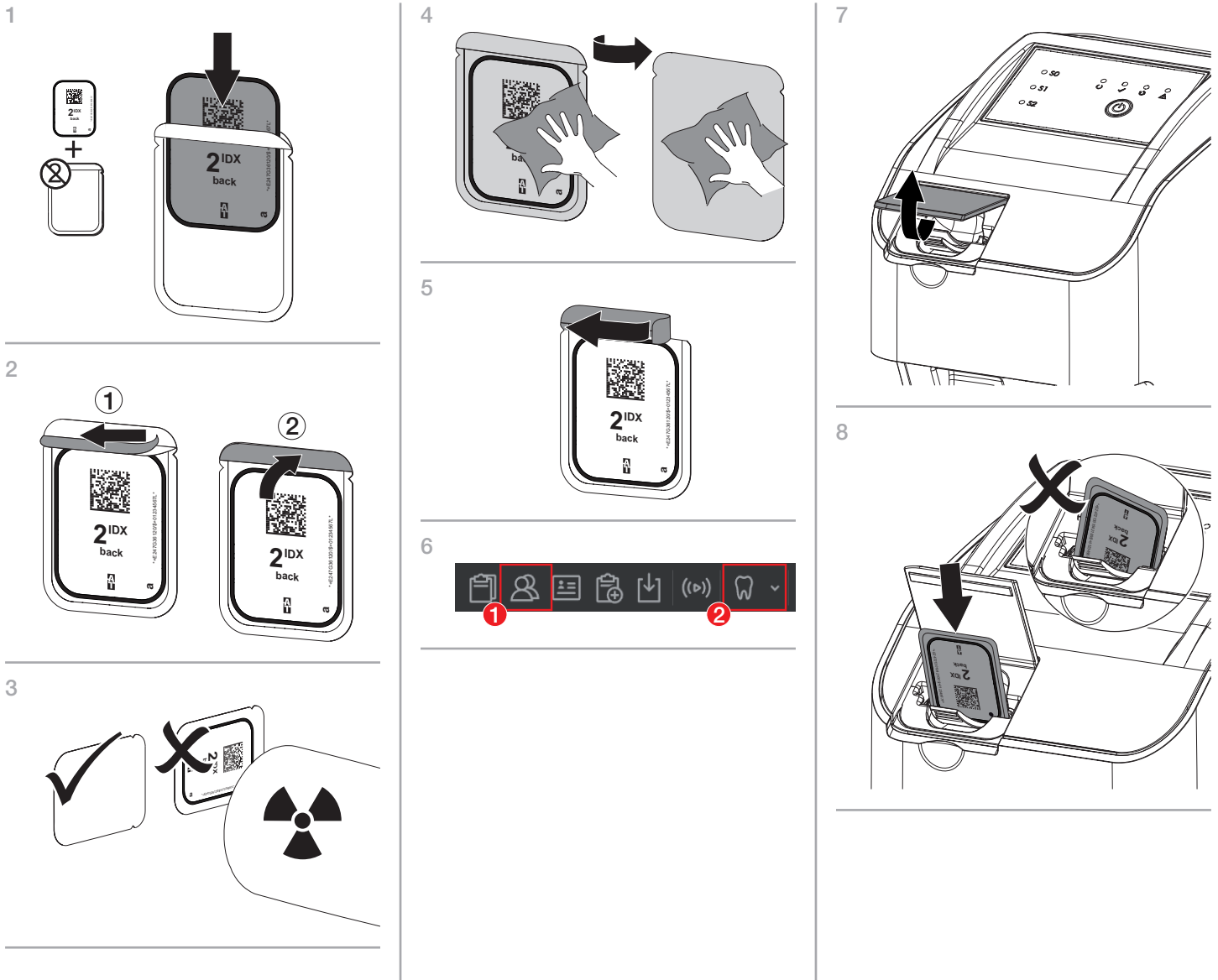

Manufactured for / Distributed by:
 Air Techniques, Inc. | 1295 Walt Whitman Road
 Melville, New York 11747- 3062, USA
 Phone: 800-247-8324 | Fax: 888-247-8481



2160100286L41 X8301 2507V002

9

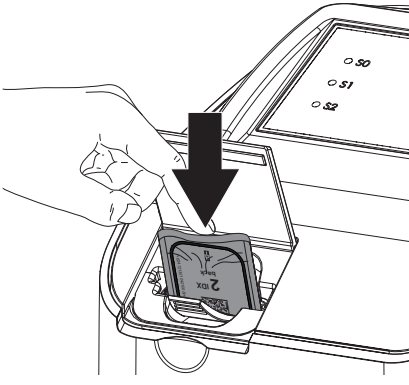

10

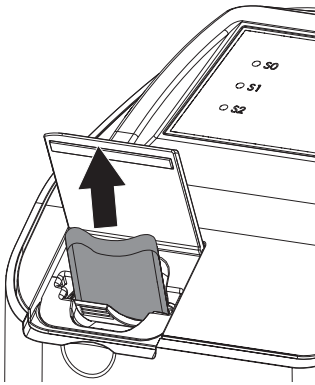

11

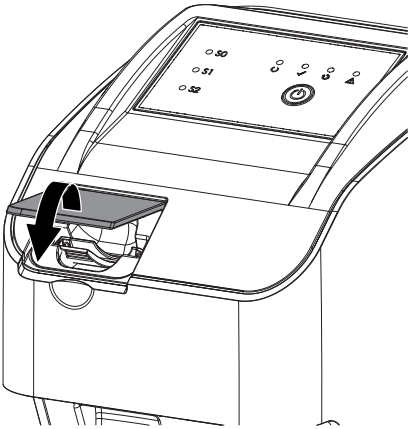

12

