

VACSTAR[®]

DENTAL VACUUM SYSTEMS

PRE-INSTALLATION GUIDE FOR MODELS VS20 & VS40

Check VacStar Model
Being Installed:

- VS20 VS40



Model VS20

Model VS40

Doctor:	_____
Address:	_____
Phone#:	_____
Dealer:	_____
Dealer Address:	_____

PRODUCT SPECIFICATIONS

Electrical	Model VS20	Model VS40
Voltage Rating	*120/220	220
Voltage Min./Max.	*108/132 or 198/242	198/242
Full Load Amps	16/8	13.4
Frequency	60	50/60
*VacStar 20 may be converted from 220 Volts to 115 Volts at installation site.		
Water		
Inlet Water Pressure (PSI)	20 - 100	20 - 100
Typical Flow Rate (gal/min) per Pump w/ HydroMiser	0.12	0.18
Flow Rate (gal/min) per Pump w/o HydroMiser	0.50	0.75
Inlet Water Temperature (°F)	40 - 75	40 - 75
Power and Heat (@ 100% duty cycle)		
Watts per Hour	750	1,230
BTU per Hour	2,560	4,197
Vacuum Level		
Preset at Factory (in Hg)	10	10

All installations must conform to local codes.

PHYSICAL CHARACTERISTICS

Model VS20		Model VS40	
Height	14 inches (36 cm)	Height	17 inches (43 cm)
Width	11 inches (28 cm)	Width	11 inches (28 cm)
Depth	11 inches (28 cm)	Depth	11 inches (28 cm)
Shipping Weight 68 lbs. (31 kg)		Shipping Weight 85 lbs. (39 kg)	

ELECTRICAL CONNECTIONS

- ⇒ All VS20 VacStars are wired directly via an electrical box that complies with local electrical codes to the VacStar's Electrical Connection Box. See Figure 1.
- ⇒ All VS40 VacStars are wired with a supplied hospital grade NEMA 6-15P line cord and requires a hospital grade 6-15R receptacle.
- ⇒ If voltage falls below the minimum or maximum during operation, a Buck/Boost Transformer must be installed. See Product Specifications.

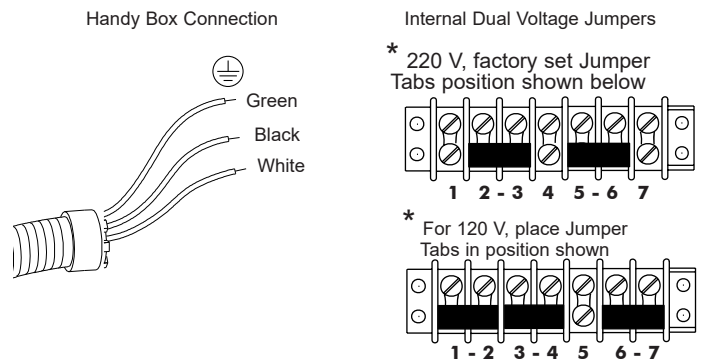
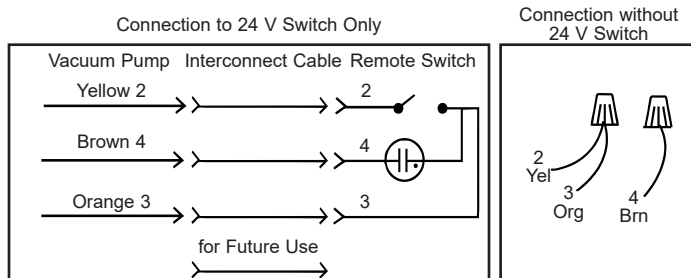

Figure 1 - VS20 Connections

24V CONNECTIONS



Use 18 Gauge, 4 Conductor, Interconnect Cable Between VacStar Pump and Remote Switch

Interior Electrical Box Connections



MEDICAL ELECTRICAL EQUIPMENT

WITH RESPECT TO ELECTRICAL SHOCK, FIRE, MECHANICAL AND OTHER SPECIFIED HAZARDS ONLY
IN ACCORDANCE WITH UL-60601-1, CAN/CSA C22.2 NO.601.1 66CA

SITE REQUIREMENTS

Electrical	VS20	VS40
Minimum Panel Breaker Rating (amps)	20A@ 120V or 20A@ 220V	20A
Minimum Wire Gauge Size	10 AWG @ 120V or 12 AWG @ 220V	12 AWG
115-Volt Buck/Boost Transformer	#67500 (2.0 KVA, VS20 Only)	Not Used
230-Volt Buck/Boost Transformer	#67002 (3.4 KVA)	#67002 (3.4 KVA)
Plumbing		
Note: Suction piping must slope at least a ¼" for each 10 feet of run towards the pump. Use PVC Schedule 40 or Copper Type M.		
Minimum CFM @ 0" Hg	15	20
Air Exhaust with Hydromiser or Air/Water Separator	2" schedule 40 pipe	2" schedule 40 pipe
Overhead Plumbing		
Main Line Diameter (Min./Max. ID in inches)	1 to 1½"	1 to 2"
End Fitting	¾" FNPT	¾" FNPT
Overhead Main Line	½" ID	½" ID
Floor Plumbing		
Main Line Diameter (Min./Max. ID in inches)	1 to 1½"	1 to 2"
End Fitting	¾" FNPT	¾" FNPT
Branch Line Diameter (Min./Max. ID in inches)	¾" to 1½"	1 to 1½"
Environmental		
Ambient Temperature (See ventilation requirements below.)	40 to 104°F (5 to 40°C)	40 to 104°F (5 to 40°C)

VENTILATION REQUIREMENTS

Equipment Room Temperature

The VAGSTAR equipment must be used in a controlled temperature environment. Maintain equipment room temperature between 40 and 105 degrees Fahrenheit. Adequate forced ventilation must be provided across the unit by placing an appropriate exhaust fan opposite an equivalent air intake vent. The fan should be higher than the associated intake vent.

Exhaust Vent Protection.

If the exhaust piping is venting to the outside of the building, precautions must be taken to protect the equipment room from weather elements and animal intrusion. This can be accomplished by using one of the three methods shown below.

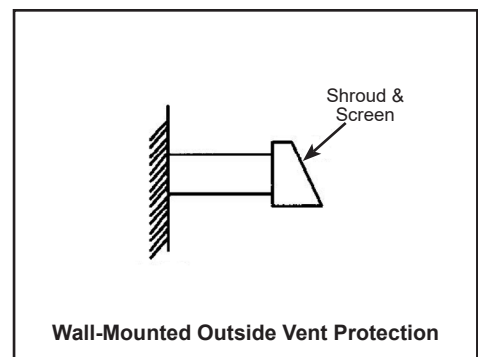
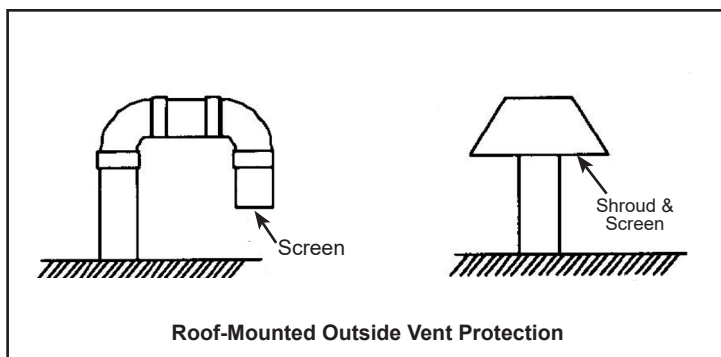

Make sure to use the required pipe type for associated system

PLUMBING INSTALLATION

SUB FLOOR INSTALLATION - THE SUB-FLOOR PLUMBING LAYOUT SHOWN BELOW IS THE RECOMMENDED LAYOUT FOR VACSTAR SYSTEM INSTALLATIONS AND SHOULD BE USED WHENEVER POSSIBLE.

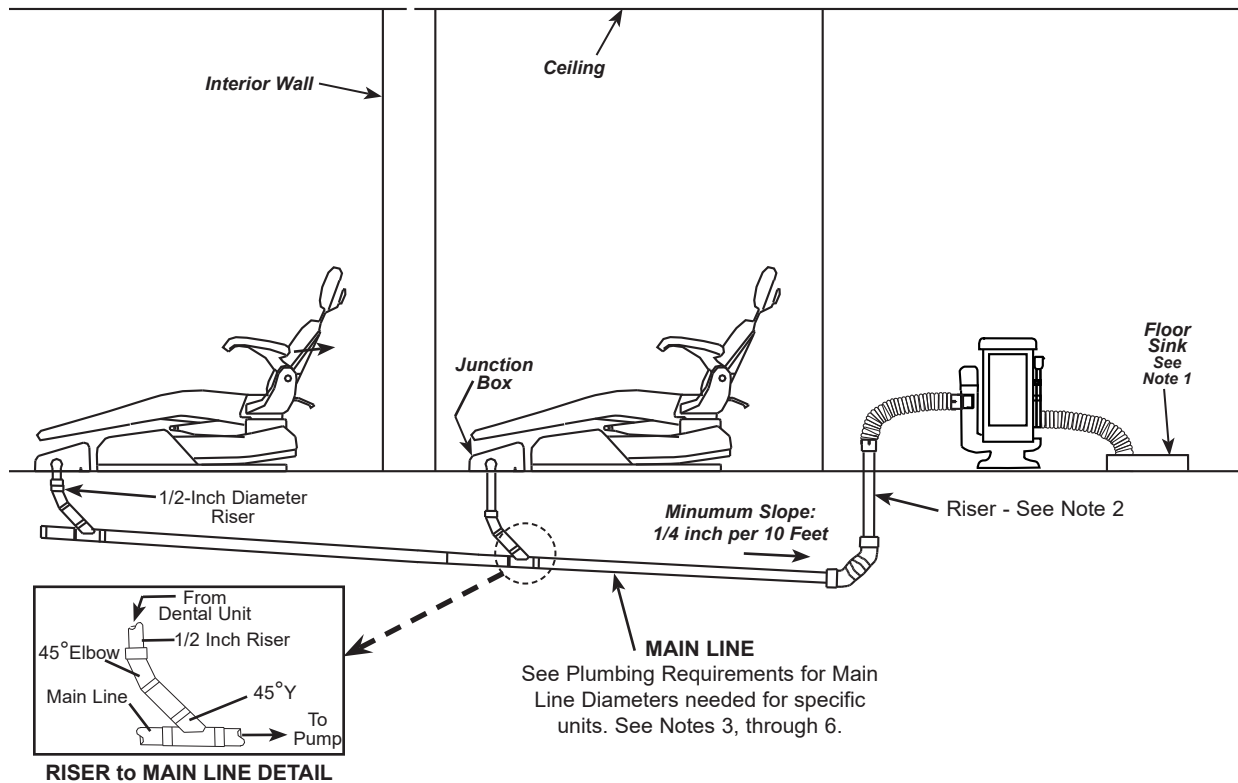

Notes:

1. See Optional Drain Connections shown below.
2. 8-Foot Maximum Height from Main Line to pump.
3. Consult Dental Unit Manufacturer's Guidelines for correct reduced size and height of termination of vacuum line inside junction box.
4. Limit branches. Orient main line under junction box or cabinet.
5. When main line is 1-1/2" I.D. or larger, use 45° Y's and elbows only.
6. Long radius 90° elbows can be used as alternates to 45° elbows.
7. A total of 8 feet of 3/4 inch hose is supplied with VacStar units. This hose must be shared between inlet and drain.

All installations must conform to local codes.

PLUMBING INSTALLATION

OVERHEAD INSTALLATION - THE OVERHEAD PLUMBING LAYOUT SHOWN BELOW IS THE ALTERNATE LAYOUT FOR VACSTAR SYSTEM INSTALLATIONS AND SHOULD BE USED ONLY WHEN UNABLE TO USE THE SUB-FLOOR PLUMBING LAYOUT.

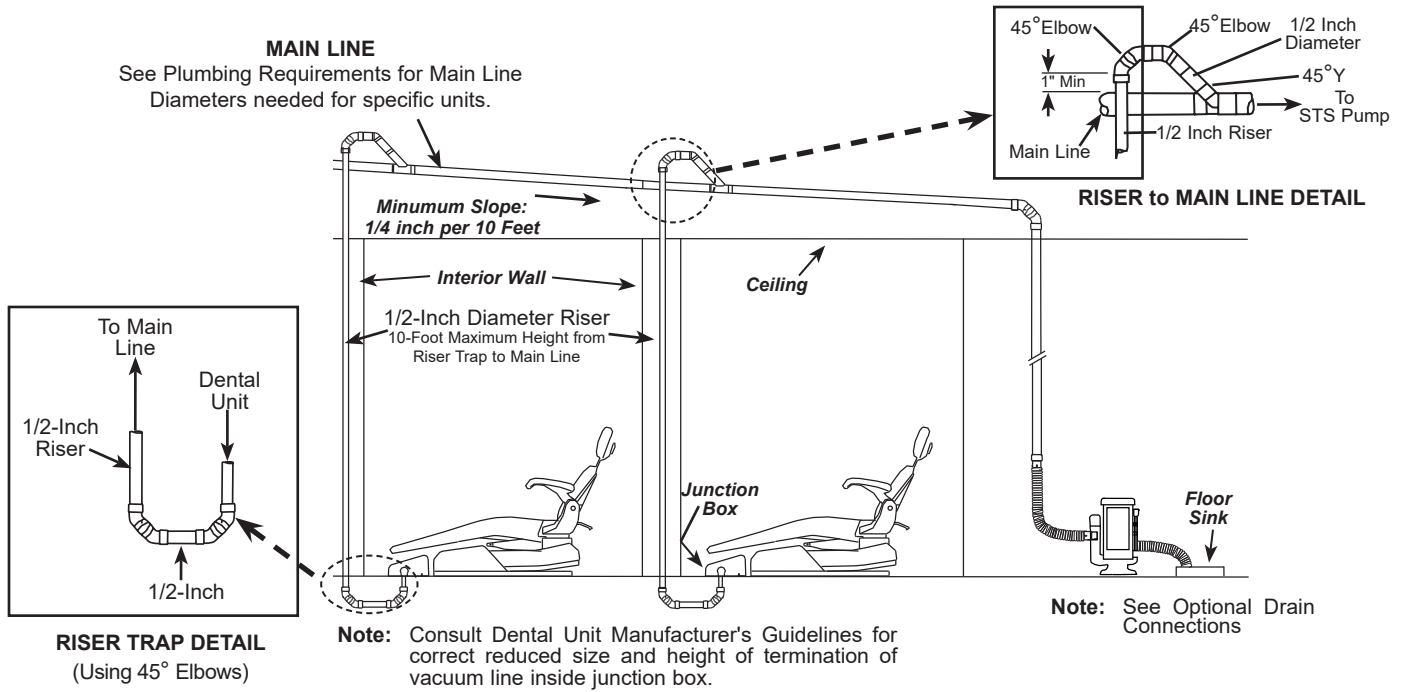

CONNECTION DETAILS ALL INSTALLATIONS -

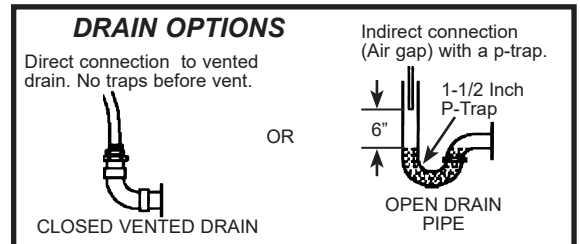
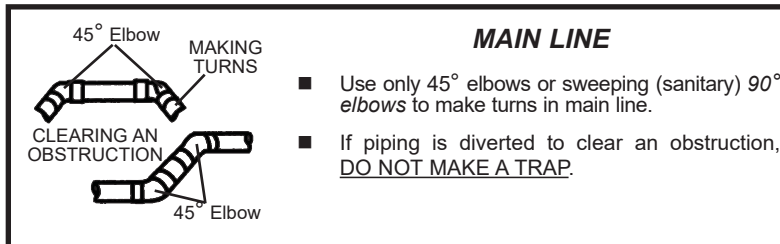

UTILITY ROOM with Air/Water Separator

Typical for both VacStar VS20 and VS40

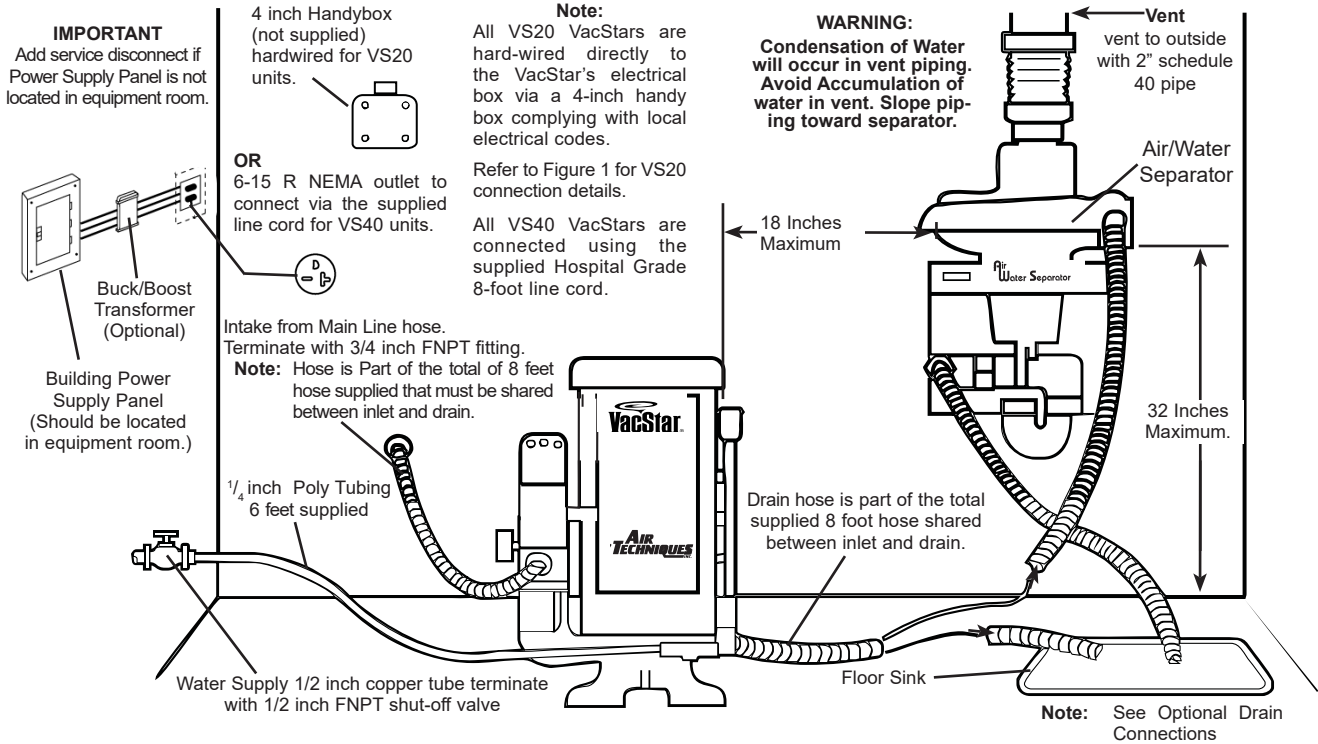

View B. VacStar with Wall-Mounted Air/Water Separator

UTILITY ROOM with Hydromiser

Typical for both VacStar VS20 and VS40

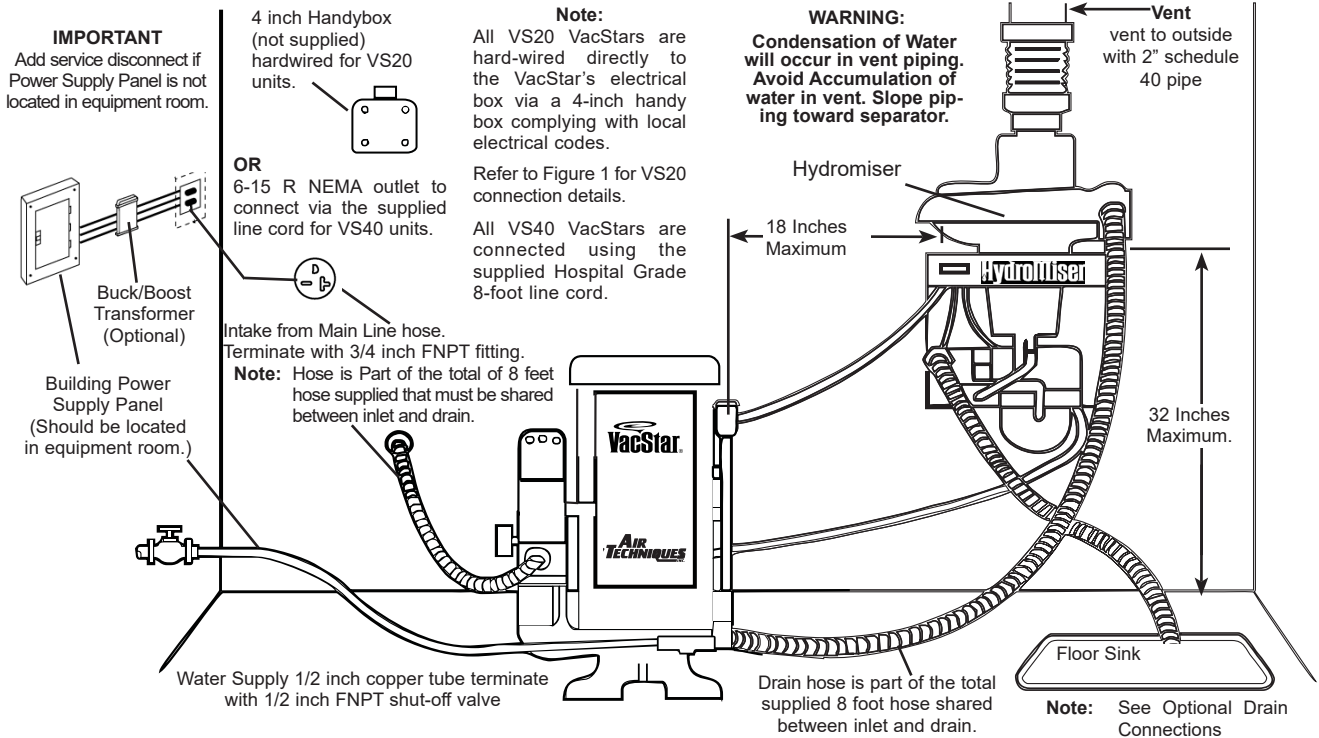

View A. VacStar with Wall-Mounted HydroMiser

All VacStar vacuums comply with NFPA 99C level 3 requirements

You can obtain more information about Air Techniques' products by visiting our web site at
www.airtechniques.com

Additional installation information is available on our Authorized Air Techniques Dealer web site at
<http://dealers.airtechniques.com>



Air Techniques Inc.
1295 Walt Whitman Road, Melville, NY 11747-3062
Website: www.airtechniques.com
1-800-AIR-TECH (1-800-247-8324)



VacStar and Hydromiser are trademarks of Air Techniques, Inc.
© 2008 Air Techniques, Inc. • Part No 55341, Rev. Q, August 2019